

FRACTIONAL MODEL ON THE DYNAMICS OF CHICKEN POX WITH VACCINATION

¹ Aguegboh, Nnaemeka S, ²Uko Ofe, ³Netochukwu E. Onyiaji, ⁴Ugwu O. Lovelyn

¹Department of Mathematics, Veritas University, Abuja ²Department of Pure and Applied Physics, Veritas University, Abuja ³Department of Mathematics, University of Nigeria, Nsukka ⁴Department of Microbiology, Veritas University, Abuja

Abstract

In this paper, we proposed a fractional SVIR order model to study the transmission dynamics of Chickenpox. We showed the existence of the equilibrium states. The basic reproduction number of the model was evaluated in terms of parameters in the model using the next generation matrix approach. We provided the conditions for the stability of the disease-free and the endemic equilibrium points. Also a detailed stability analysis of the model was carried out. Also, numerical simulations of the model were carried out using Adams-type predictor-corrector method and the paper provided a theoretical basis to control the spread of Chickenpox.

Keywords: Fractional calculus, Chickenpox, Numerical solution, Predictor-corrector method

1 Introduction

Chicken pox also known as Varicella is a viral disease caused by an infectious disease virus known as Varicella-Zoster virus. It is a contagious viral disease that predominantly affects children. It is often a mild illness, characterized by an itchy rash on the face, scalp and trunk with pink spots and tiny fluid-filled blisters that dries and become scabs four to five days later. Serious complications, although rare can occur mainly in infants, adolescents, adults and persons with a weakened immune system. Those complications include bacterial infections of skin blisters, pneumonia and encephalitis (inflammation of the brain). In temperate climates, such as the Northeast, chicken pox occurs most frequently in the late winter and early spring.[1] Chicken pox is a common childhood illness with 90 of the cases occurring in children younger than ten (10) years of age. The risk of complications depends on age and level of immunity. Chicken pox is characterized by peculiar symptoms such as slight fever, fatigue, difficulty in breathing, malaise, irritability, after some days, symptoms like itchy rashes may appear. The rashes starts with crops of small red bumps on the stomach or back and spread to the face, limbs and other

parts of the body except palms and foot. The itchy rashes then develop into numbers between 250 and 500 which becomes blisters and last for a maximum of 5 to 7 days.[2]

Berreta and Capasso [3] studied rubella epidemiology in South East England. The disease was characterized by age-dependent changes in the pattern of virus transmission. The rate of infection was low in children than in adults. Immunization against people raised levels of immunity in both children and adults. On average, antibody concentrations recorded a reduction with age and low in vaccinated females than in unvaccinated males. Kermack and McKendrick [4] studied epidemics of measles in United Kingdom. In their study the dynamics of the disease depended on infections rate, the removal rate and relative removal rate. Their work observed that the disease threshold occurs when basic reproductive number equals to one. Li and Zou [5] applied a generalization of the Kermack and McKendrick [4] model to a patchy environment for a disease with latency. Their work assumed that the infectious disease had a fixed latent period in a population. In a paper Ferguson et al [1], reviewed and discussed different hypotheses of how this re-emergence of virus comes about. From these hypotheses, and epidemiological data describing the initial transmission of the virus, a mathematical model of primary disease (varicella) and reactivated disease (zoster) in developed countries was derived. Most researchers in the past hardly discussed transmission dynamics of Chickenpox with vaccination by applying fractional calculus. Inspired by this, in the present work we considered the fractional order SVIR model by using a system of fractional order differential equation in the sense of Caputo, for prevention of Chickenpox with vaccination. By applying fractional calculus, we gave a detailed analysis on the stability of the disease free and endemic equilibrium points. Also numerical simulation was carried out to illustrate the obtained results.

Mathematical modeling of infectious diseases using integer order system of differential equations has gained a lot of attention over the past years[6]. However, epidemiological models and other models in science and engineering have successfully been formulated and analyzed using fractional derivatives and integrals[7, 8]. Fractional derivatives are nonlocal as opposed to the local behavior of integer derivatives. This implies that the next state of a fractional system does not only depend on its current state but also upon all of its historical states [15].

2 Fractional Order Calculus

Fractional order models have been the focus of many studies due to their frequent appearance in various applications in several scientific fields. We first give the definition of fractional-order integration and fractional order differentiation. For the concept of fractional derivative, we will consider Caputo's definition. It has an advantage of dealing properly with initial value problem.

2.1 Definition of terms

Definition 1. The Caputo Fractional derivative of order α of a function $f : \mathfrak{R}^+ \rightarrow \mathfrak{R}$ is given by

$$D_t^\alpha f(t) = \frac{1}{\Gamma(\alpha - n)} \int_\alpha^t \frac{f^{(n)}(\tau) d\tau}{(t - \tau)^{\alpha+1-n}} \quad (n - 1 < \alpha \leq n) \quad (1)$$

Definition 2. The formular for the Laplace transform of the Caputo derivative is given by

$$\int_0^\infty e^{-pt} \{D_t^\alpha f(t)\} dt = p^\alpha F(p) - \sum_{k=0}^{n-1} p^{\alpha-k-1} f^{(k)}(0), \quad (n-1 < \alpha \leq n) \quad (2)$$

Definition 3. The Fractional integral of order α of a function $f : \mathfrak{R}^+ \rightarrow \mathfrak{R}$ is given by

$$J^\alpha(f(x)) = \frac{1}{\Gamma(\alpha)} \int_0^x (x-t)^{\alpha-1} f(t) dt, \quad \alpha > 0, x > 0 \quad (3)$$

Definition 4. The fractional integral of the Caputo Fractional derivative of order α of a function $f : \mathfrak{R}^+ \rightarrow \mathfrak{R}$ is given by

$$J^\alpha \{D^\alpha f(t)\} = f(t) - \sum_{k=0}^{n-1} f^{(k)}(0) \frac{t^k}{k!}, \quad t > 0 \quad (4)$$

Definition 5. A two-parameter function of the Mittag-Leffler type is defined by the series expansion

$$E_{\alpha,\beta}(z) = \sum_{k=0}^{\infty} \frac{z^k}{\Gamma(\alpha k + \beta)}, \quad (\alpha, \beta > 0) \quad (5)$$

3 Model Formulation

The SVIR model is based on the following assumptions:

1. Let S, I, V, R denote the densities (or fractions) of Susceptible class, infected class, vaccinated class and recovered/removed individuals respectively.
2. We assumed that the susceptible individuals are recruited at an influx rate of Λ .
3. We assumed that μ be the natural death rate of the population.
4. Let β be the transmission rate of disease when susceptible individuals contact with infected individuals.
5. Let γ be the recovery rate of infected individuals.
6. The recovered individuals are assumed to have immunity (so called natural immunity) against the disease.
7. Let θ be the rate at which susceptible individuals are removed into the vaccinated class.
8. Let γ_1 be the average rate for the vaccinated individuals obtaining immunity and move into the recovered population.
9. We assumed that before obtaining immunity the vaccines still have the possibility of infection with a disease transmission rate β_1 while contacting the infected individuals.

Now, putting these assumptions together, we have the model flow diagram and thus the model equations for the transmission of Chickenpox.

The schematic diagram of the disease on which we base our model is as follow:

Figure 1: Model Flow Diagram.

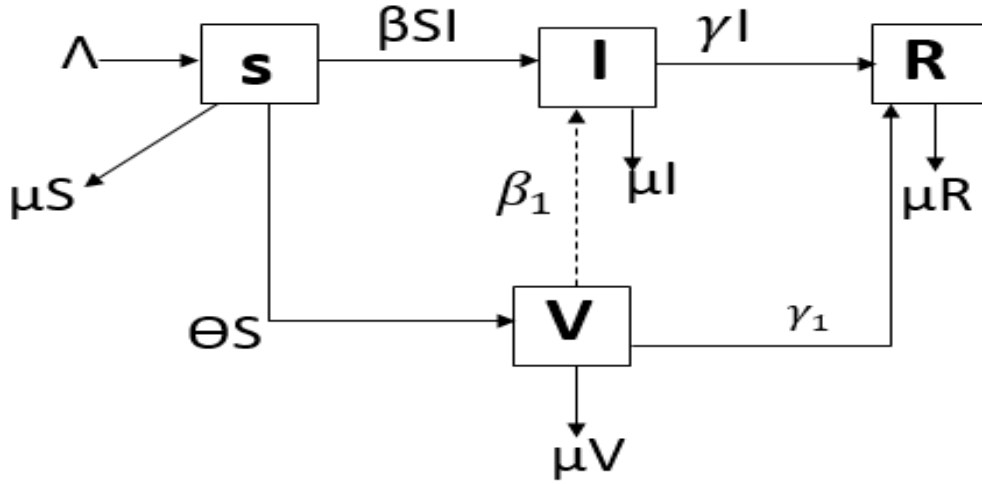

3.1 Model Equation

$$\begin{cases} D_t^\alpha S(t) = \Lambda - \beta SI - \theta S - \mu S \\ D_t^\alpha V(t) = \theta S - \beta_1 VI - (\gamma_1 + \mu)V \\ D_t^\alpha I(t) = \beta SI + \beta_1 VI - (\gamma + \mu)I \\ D_t^\alpha R(t) = \gamma V + \gamma I + \mu R \end{cases} \quad (6)$$

This type of mathematical formulation has been considered by many researchers [see, e.g., [9, 10]]. It is very clear that, there is mismatch of model dimensions in the fractional order model (6), but this drawback of fractionalization has been addressed by Diethelm [11]. In his research paper, he formulated a fractional order compartmental model for dengue fever infection. He demonstrated the effectiveness of the method using dengue fever epidemic data from Cape Verde Islands. Sardar et al [12] proposed and analysed a similar model using the method by [11]. They found out that for epidemic models with memory in both vector and host populations, simulations results with data gives better representation than integer order models. Following the method by Diethelm [11], system (6) becomes:

$$\begin{cases} D_t^\alpha S(t) = \Lambda^\alpha - \beta^\alpha SI - \theta^\alpha S - \mu^\alpha S \\ D_t^\alpha V(t) = \theta^\alpha S - \beta_1^\alpha VI - (\gamma_1^\alpha + \mu^\alpha)V \\ D_t^\alpha I(t) = \beta^\alpha SI + \beta_1^\alpha VI - (\gamma^\alpha + \mu^\alpha)I \\ D_t^\alpha R(t) = \gamma^\alpha V + \gamma^\alpha I + \mu^\alpha R \end{cases} \quad (7)$$

where D^α is the Caputo fractional derivative. Because (7) studies the dynamics of human populations, all the parameters are assumed to be non-negative. Furthermore, it can be shown that all state variables

of the model are non-negative for all time $t \geq 0$.

3.2 Invariant Region

Lemma 4. The closed set $\Omega = \{(S, V, I, R) \in R_+^4 : S + I + R + A \leq \frac{\Lambda}{\mu}\}$ is positively invariant with respect to model (7)

Proof

The fractional derivative of the total human population, obtained by adding all the human equations of model (7), is given by

$$D^\alpha N(t) = \Lambda - \mu N(t) \tag{8}$$

Taking the Laplace transform of (8) gives:

$$\begin{aligned} S^\alpha N(s) - S^{\alpha-1}N(0) &= \frac{\Lambda}{S} - \mu N(s) \\ \Rightarrow N(s) &= \frac{\Lambda}{S(S^\alpha + \mu)} + \frac{S^{\alpha-1}}{s^\alpha + \mu}N(0) \end{aligned} \tag{9}$$

Taking the inverse Laplace transform of (9), we have:

$$N(t) = N(0)E_{\alpha,1}(-\mu t^\alpha) + \Lambda t^\alpha E_{\alpha,\alpha+1}(-\mu t^\alpha) \tag{10}$$

where $E_{\alpha,\beta}$ is the Mittag-Leffler function. But the fact that the Mittag-Leffler functions has an asymptotic behavior[13, 14], it follows that:

$$E_{\alpha,1}N(t) = \sum_{k=0}^{\infty} \frac{N^k(t)}{\Gamma(\alpha k + 1)}, \alpha > 0 \tag{11}$$

$$E_{\alpha,\alpha+1}N(t) = \sum_{k=0}^{\infty} \frac{N^k(t)}{\Gamma(\alpha k + \alpha + 1)}, \alpha > 0 \tag{12}$$

Expanding (11), we have

$$E_{\alpha,1}N(t) = \frac{1}{\Gamma 1} + \frac{N(t)}{\Gamma(\alpha + 1)} + \frac{N^2(t)}{\Gamma(2\alpha + 1)} + \dots$$

Expanding (12), we have

$$E_{\alpha,\alpha+1}N(t) = \frac{1}{\Gamma(\alpha + 1)} + \frac{N(t)}{\Gamma(2\alpha + 1)} + \frac{N^2(t)}{\Gamma(3\alpha + 1)} + \dots$$

Since Mittag-Leffler function has an asymptotic property, we have

$$N(t) = 1 + O(N)$$

Taking limit as $k \rightarrow \infty$, we have

$$N(t) \approx 1$$

Then, it is clear that Ω is a positive invariant set. Therefore, all solutions of the model with initial conditions in Ω remain in Ω for all $t > 0$. Then, $\Omega = N(t) > 0$ implies that it is feasible with respect to model (7).

5 Model Analysis

5.1 The Basic Reproduction Number, R_0

To calculate the reproduction number (R_0), we use the Next Generation Matrix. It is comprised of two parts: F and V^{-1} ,

$$\therefore R_0 = \rho(FV^{-1})$$

Where

$$F = \left| \frac{\partial f_i x(0)}{\partial x_j} \right|, \quad V = \left| \frac{\partial v_i x(0)}{\partial x_j} \right|$$

ρ = spectral value (highest eigenvalue)

On the estimation, We used the following disease compartments:

$$\begin{aligned} D_t^\alpha V(t) &= \theta^\alpha S - \beta_1^\alpha V I - (\gamma_1^\alpha + \mu^\alpha) V \\ D_t^\alpha I(t) &= \beta^\alpha S I + \beta_1^\alpha V I - (\gamma^\alpha + \mu^\alpha) I \end{aligned} \tag{13}$$

Define

$$\begin{aligned} F_i &= \begin{pmatrix} -\beta_1^\alpha V I \\ \beta^\alpha S I + \beta_1^\alpha V I \end{pmatrix} \\ -V_i &= \begin{pmatrix} \theta^\alpha S - (\gamma_1^\alpha + \mu^\alpha) V \\ -(\gamma^\alpha + \mu^\alpha) I \end{pmatrix} \\ FV^{-1} &= \begin{pmatrix} 0 & 0 \\ 0 & \frac{\beta^\alpha \Lambda^\alpha}{(\theta^\alpha + \mu^\alpha)(\gamma^\alpha + \mu^\alpha)} \end{pmatrix} \end{aligned}$$

Hence,

$$R_0 = \frac{\beta^\alpha \Lambda^\alpha}{(\theta^\alpha + \mu^\alpha)(\gamma^\alpha + \mu^\alpha)} \tag{14}$$

5.2 Equilibrium Points and their Local Asymptotic Stability

To determine the model equilibria of the fractional order model (7), let

$$\begin{cases} D_t^\alpha S(t) = 0 \\ D_t^\alpha V(t) = 0 \\ D_t^\alpha I(t) = 0 \\ D_t^\alpha R(t) = 0 \end{cases} \quad (15)$$

Then system (7) becomes:

$$\begin{cases} 0 = \Lambda^\alpha - \beta^\alpha SI - \theta^\alpha S - \mu^\alpha S \\ 0 = \theta^\alpha S - \beta_1^\alpha VI - (\gamma_1^\alpha + \mu^\alpha)V \\ 0 = \beta^\alpha SI + \beta_1^\alpha VI - (\gamma^\alpha + \mu^\alpha)I \\ 0 = \gamma^\alpha V + \gamma^\alpha I + \mu^\alpha R \end{cases} \quad (16)$$

On solving the right hand side of equation (16) gives the disease equilibrium state of the model. Thus, the DFE is given by $E^0(S^0, V^0, I^0, R^0) = (\frac{\Lambda^\alpha}{\mu^\alpha + \theta^\alpha}, 0, 0, 0)$

5.2.1 Stability analysis of the disease free equilibrium point

It is important to remark that the disease free equilibrium point is where the infectives in model equals zero ($I = V = R = 0$). The Jacobian matrix $J(E^0)$ for the fractional order model (7) computed at E^0 is given as:

$$J(E^0) = \begin{pmatrix} \frac{\partial S}{\partial S} & \frac{\partial S}{\partial V} & \frac{\partial S}{\partial I} & \frac{\partial S}{\partial R} \\ \frac{\partial V}{\partial S} & \frac{\partial V}{\partial V} & \frac{\partial V}{\partial I} & \frac{\partial V}{\partial R} \\ \frac{\partial I}{\partial S} & \frac{\partial I}{\partial V} & \frac{\partial I}{\partial I} & \frac{\partial I}{\partial R} \\ \frac{\partial R}{\partial S} & \frac{\partial R}{\partial V} & \frac{\partial R}{\partial I} & \frac{\partial R}{\partial R} \end{pmatrix} \quad (17)$$

This gives

$$J(E^0) = \begin{pmatrix} -(\beta^\alpha I + \theta^\alpha + \mu^\alpha) & 0 & -\beta^\alpha S & 0 \\ \theta^\alpha & -(\beta_1^\alpha I + \gamma_1^\alpha + \mu^\alpha) & -\beta_1^\alpha V & 0 \\ \beta^\alpha I & \beta_1^\alpha I & \beta^\alpha S + \beta_1^\alpha V - (\gamma^\alpha + \mu^\alpha) & 0 \\ 0 & \gamma_1^\alpha & \gamma^\alpha & -\mu^\alpha \end{pmatrix} \quad (18)$$

Now evaluating the Jacobian at DFE, we obtain

$$J(E^0) = \begin{pmatrix} -(\theta^\alpha + \mu^\alpha) & 0 & \frac{-\beta^\alpha \Lambda^\alpha}{(\mu^\alpha + \theta^\alpha)} & 0 \\ \theta^\alpha & -(\gamma_1^\alpha + \mu^\alpha) & 0 & 0 \\ 0 & 0 & \frac{\beta^\alpha \Lambda^\alpha}{(\mu^\alpha + \theta^\alpha)} - (\gamma^\alpha + \mu^\alpha) & 0 \\ 0 & \gamma_1^\alpha & \gamma^\alpha & -\mu^\alpha \end{pmatrix} \quad (19)$$

Theorem 5.1. The equilibrium point E^0 of system (7) is locally asymptotically stable if $R_0 < 1$ and unstable if $R_0 > 1$

Proof: The equilibrium point E^0 is locally asymptotically stable if all the eigenvalues λ_i , $i = 1, 2, 3, 4$ of $J(E^0)$ satisfy the condition [19]: $|\arg(\lambda_i)| > \frac{\alpha\pi}{2}$.

From the Jacobian matrix $J(E^0)$, it is clear that $\lambda_1 = -\mu^\alpha$, $\lambda_2 = -(\mu^\alpha + \theta^\alpha)$, $\lambda_3 = -(\gamma^\alpha + \mu^\alpha)$ and therefore $\lambda_4 = \frac{\beta^\alpha \Lambda^\alpha}{(\mu^\alpha + \theta^\alpha)} - (\gamma^\alpha + \mu^\alpha) = (R_0 - 1)(\gamma^\alpha + \mu^\alpha) < 0$ if $R_0 < 1$, then all the eigenvalues λ_i satisfy the condition $|\arg(\lambda_i)| > \frac{\alpha\pi}{2}$. Hence, the disease-free equilibrium is locally asymptotically stable if $R_0 < 1$ and unstable if $R_0 > 1$.

5.3 Stability analysis of the Endemic equilibrium point

At EEP, the Jacobian matrix becomes:

$$J(E^*) = \begin{pmatrix} -(\beta^\alpha I^* + \theta^\alpha + \mu^\alpha) & 0 & -\beta^\alpha S^* & 0 \\ \theta^\alpha & -(\beta_1^\alpha I^* + \gamma_1^\alpha + \mu^\alpha) & -\beta_1^\alpha V^* & 0 \\ \beta^\alpha I^* & \beta_1^\alpha I^* & \beta^\alpha S^* + \beta_1^\alpha V^* - (\gamma^\alpha + \mu^\alpha) & 0 \\ 0 & \gamma_1^\alpha & \gamma^\alpha & -\mu^\alpha \end{pmatrix} \quad (20)$$

where

$$S^* = \frac{\Lambda^\alpha}{\beta^\alpha I^*}$$

$$V^* = \frac{\theta^\alpha S^*}{\beta_1^\alpha I^* + (\gamma_1^\alpha + \mu^\alpha)}$$

$$I^* = \frac{\Lambda^\alpha - \theta^\alpha S^* - \mu^\alpha S^*}{\beta^\alpha S^*}$$

$$R^* = \frac{\theta^\alpha \gamma_1^\alpha S^*}{\mu^\alpha (\gamma_1^\alpha + \mu^\alpha + \beta^\alpha I^*)} + \frac{\gamma^\alpha I^*}{\mu^\alpha}$$

The eigenvalues are obtained from the characteristic equation:

$$|J(E^*) - \lambda I| = 0 \quad (21)$$

Thus,

$$\begin{bmatrix} -(\beta^\alpha I^* + \theta^\alpha + \mu^\alpha) & 0 & -\beta^\alpha S^* & 0 \\ \theta^\alpha & -(\beta_1^\alpha I^* + \gamma_1^\alpha + \mu^\alpha) & -\beta_1^\alpha V^* & 0 \\ \beta^\alpha I^* & \beta_1^\alpha I^* & \beta^\alpha S^* + \beta_1^\alpha V^* - (\gamma^\alpha + \mu^\alpha) & 0 \\ 0 & \gamma_1^\alpha & \gamma^\alpha & -\mu^\alpha \end{bmatrix} = 0 \quad (22)$$

The characteristic equation $J(E^*)$ is given as

$$(-\mu^\alpha - \lambda)(\lambda^3 + a_1\lambda^2 + a_2\lambda + a_3) = 0 \quad (23)$$

Where

$$a_1 = \frac{\mu^\alpha}{S^*} + \frac{\theta^\alpha S^*}{V^*} > 0, a_2 = \frac{\theta^\alpha \mu^\alpha}{V^*} + \beta_1^{2\alpha} V^* I^* + \beta^{2\alpha} S^* I^* > 0, a_3 = \theta^\alpha \beta^\alpha \beta_1^\alpha S^* I^* + \frac{\theta^\alpha \beta^{2\alpha} S^{*2} I^*}{V^*} + \frac{\mu^\alpha \beta_1^2 \alpha V^* I^*}{S^*} > 0.$$

Since $a_1 a_2 > a_3$, by Routh-Hurwitz criterion [6], the eigenvalues have negative real parts. Therefore, the endemic equilibrium point is stable.

6 Numerical Simulation

In this section, the predictor corrector method is applied to get the numerical solutions of system (7) [12]. We will propose two cases for the model (7) with various values of parameters. In the first case, $\lambda = 1, \beta = 10, \mu = 1, \gamma = 4, \beta_1 = 2, \theta = 10, \gamma_1 = 8$ [13] and with initial conditions: $S(0) = 500, E(0) = 5, I(0) = 20, R(0) = 10$ (Estimated). In this case, $R_0 = 0.2 < 1$, then the disease free equilibrium is locally stable and the disease dies out. In the second case, $\lambda = 1, \beta = 20, \mu = 1, \gamma = 1, \beta_1 = 2, \theta = 5, \gamma_1 = 8$ with same initial conditions, then $R = 1.67 > 1$ which implies that the disease still persists and the endemic equilibrium is globally stable.

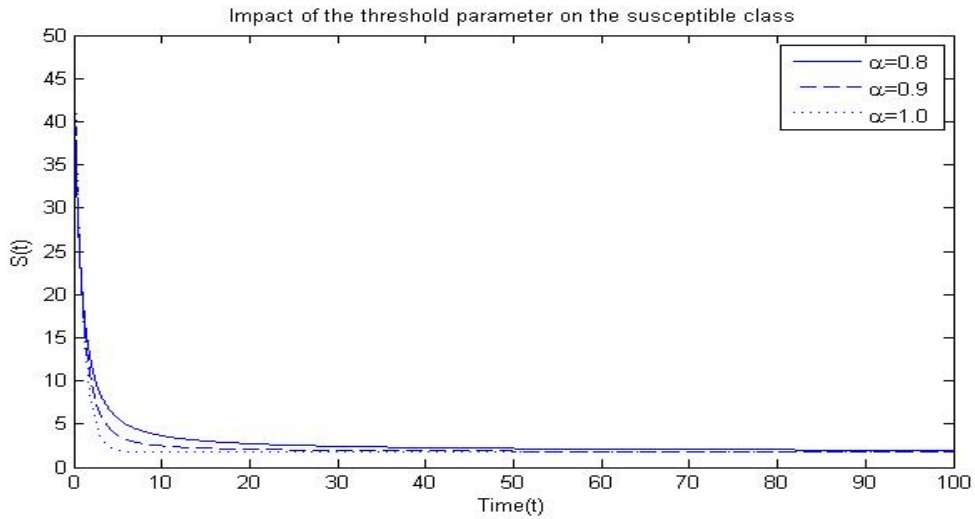

Figure 2: Dynamics of the Susceptible Population.

This graph shows the variation of the susceptible population with time when $R_0 < 1$. This shows that the model would be asymptotically stable when $R_0 < 1$ which means that the virus will not invade the population rather it will die off with time as the decreasing curve does not intercept the horizontal axis. This also shows that the fractional order (like $\alpha = 0.8$) gave a better result than the integer order ($\alpha = 1.0$).

The density of the Vaccinated nodes.

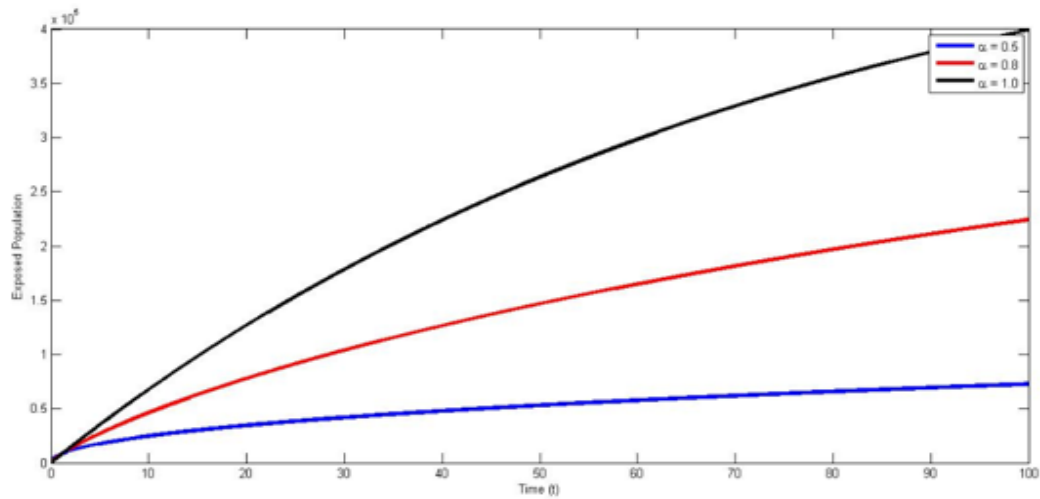

Figure 3: Dynamics of the Vaccinated population with $R_0 < 1$

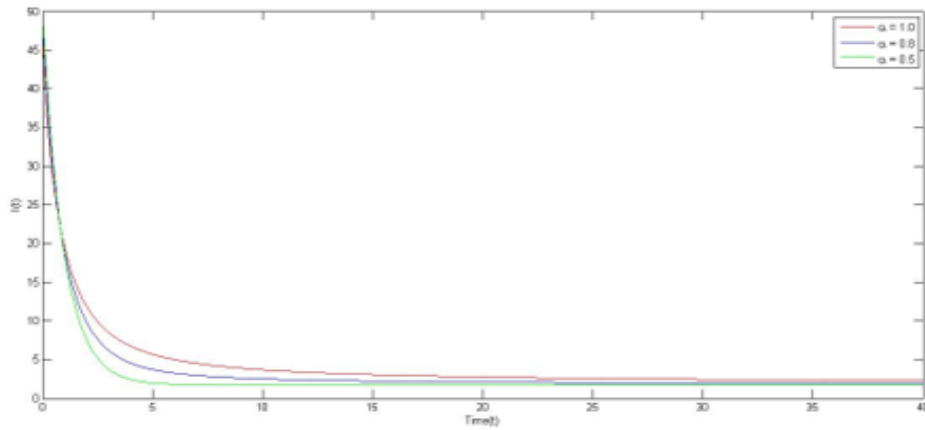

Figure 4: Dynamics of the Infectious Class with time when $\gamma = 4.0$

This shows that Infectious class decreases over time when $R_0 < 1$.

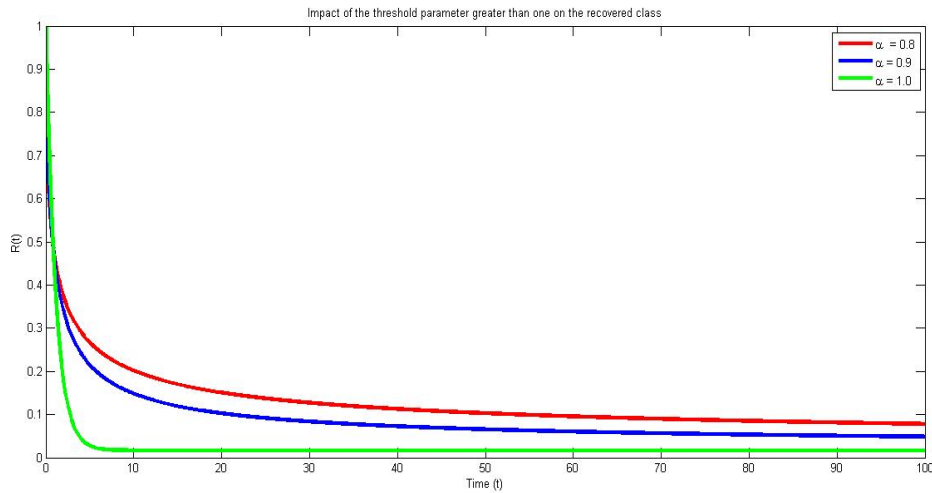

Figure 5: Dynamics of the Recovered Class

This shows that the Recovered class increases over time when $R_0 < 1$. Clearly, it can also be seen that as the value of α increases, the model becomes unstable telling us that the fractional case gives a better result than the classical case.

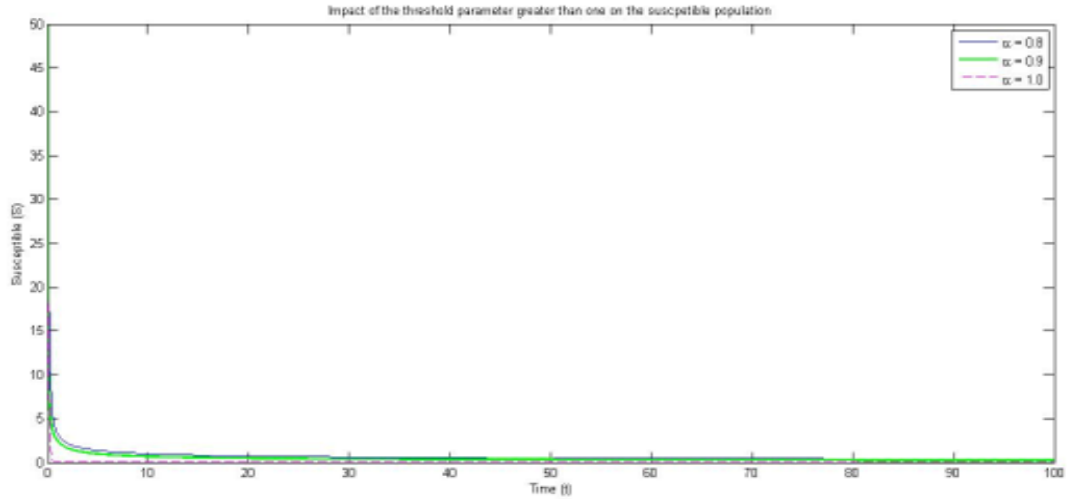

Figure 6: Dynamics of the Susceptible Class

The density of the Susceptible nodes with $R_0 > 1$ with different values of α .

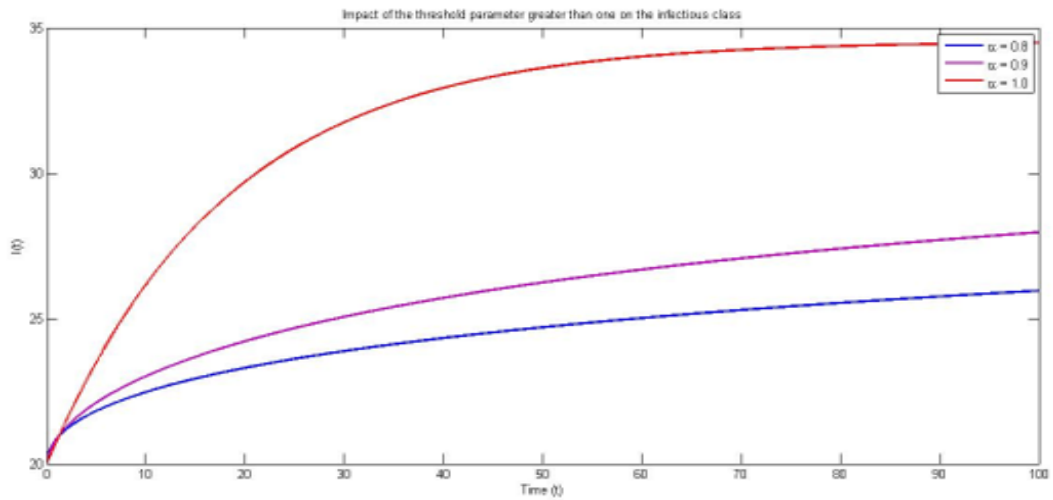

Figure 7: Dynamics of the Infectious Class

The density of the Infectious nodes with $R_0 > 1$ with different values of α .

6.1 Discussion of results

Figure 1 showed that the population of the susceptible class reduced with time for $R_0 < 1$ and as such shows that the disease will die off with time. Also, we could see clearly that the fractional case gave a better result than the classical case. When $R_0 > 1$ from the graph 6, we see that the endemic equilibrium becomes stable at some point as the susceptible population did not grow unboundedly with time. Also, we could see that a reduction in the contact rate, β would mitigate so much the spread of the disease. Figure 2 shows how the vaccinated class varies with time when $R_0 < 1$. We could observe that the vaccinated population grew with time and that showed the equilibrium of the local equilibrium

point is stable and that same applies with figure 3 and figure 4. Figure 4 and figure 7 show how the infected class varies with time as we vary the threshold parameter. It also shows that the fractional model is better than the classical model

7 Conclusion

In this paper, the fractional order model was introduced into a compartmental SVIR model for Chick-enpox that describes the dynamics of the virus which also displays the suitable control and preventive measures that restrains the spread of the virus. The result shows that the solution continuously depends on the time-fractional derivative. When $\alpha \rightarrow 1$, the solution of the fractional model reduces to the standard solution of the integer order model. The result also shows that the fractional order model gives a better result than the integer model.

References

- [1] N. M. Ferguson, R. M. Anderson and G. P. Garnett, "Mass vaccination to control chicken-pox: The influence of zoster," *Medicinal sciences*, vol. 93, (1996) 7231-7235.
- [2] O. Forde and J.A.P Meeker , "Mathematical model on the transmission dynamics of Vericella with treatment," *Journal of Mathematical biology*, no. 2, (2010) 265-382.
- [3] E. Berretta and V. Capasso, "On the general structure of the epidemic system: Global asymptotic stability," *Comp. and Maths. with Appls.*, no. 12A, (1986) 677-694.
- [4] W. O. Kermack and A. G. Mckendrick, "Contributions to the mathematical theory of epidemics, part 1," *Proceedings of the Royal Society of Edinburgh*, vol. 115, (1927) 700-721.
- [5] J. Li and X. Zou, "Generalization of the Kermack-Mckendrick SIR Model to a Patchy Environment for a disease with Latency," vol. 4, no. 2, (2009) 92-118.
- [6] Nnaemeka S. A., and Amanso O., "Analysis of a model on the transmission dynamics (with prevention and control) of Hepatitis B", *Journal of Fractional Calculus and Application*, Vol. 12(1), (2021) 76-89.
- [7] Gonza, L.P., Arenas, J. A., and Chen-Chapentier B. "A Fractional order Epidemic Model for the Simulation of outbreaks of influenza (HINI). *Mathematical Methods in the Applied Sciences*" , (2014) 2218-2226.
- [8] Petras, I. *Fractional Order non linear systems: Modelling, analysis and Simulation*. Springer Verley, (2011).

- [9] E. Ahmed, A. M. A. El-Sayed and H. A. A. El-Saka, "Equilibrium points, stability and numerical solutions of fractional-order predator-prey and rabies models," *J. Math. Anal. Appl.*, no. 325, (2007) 542-553.
- [10] I. Area, H. Batarfi, J. Losada, JJ Nieto, M. Shammakh and A. Torres, "On a fractional order ebola epidemic model," *Advances in Difference Equations*, (2015) 278.
- [11] K. Diethelm, "A fractional calculus based model for the simulation of an outbreak of dengue fever," *Nonlinear Dynamics*, vol. 71, no. 4, (2011) 613-619.
- [12] T. Sardar, S. Rana, S. Bhattacharya, K. Al-Khaled and J. Chattopadhyay, "A generic model for a single strain mosquito-transmitted disease with memory on the host and the vector," *Mathematical Biosciences*, no. 263, (2015) 18-36.
- [13] I. Podlubny, *Fractional Differential Equations*, Academic Press, (1999).
- [14] R. Gorenglo, J. Loutchko and Y. Luchko, "Computation of the Mittag-Leffler function and its derivative," *Fractional Calculus and Applied Analysis*, vol. 5, no. 4, (2002) 491-518.
- [15] Aguegboh, N.S., Nwokoye, N.R., Onyiaji, N.E., Amanso, O.R. and Oranugo, D.O. (2020) A Fractional Order Model for the Transmission Dynamics of Measles with Vaccination. *Open Access Library Journal* , 7: e6670. <https://doi.org/10.4236/oalib.1106670>.